



**disinfection &  
decontamination**

**2020**  
**catalogue**  
**catalogo**



**misting**  
driven by **excellence**



# TecnoCooling

world leader in misting systems equipment manufacturing

TecnoCooling offers now the widest range of misting solutions on the market. We are engaged every day to study innovative products that allow us to be your first choice in the world of misting.

**TecnoCooling** is one of the world's largest misting pumps and accessories manufacturers with distribution agreements across five continents.

The group's wide portfolio of brands includes TecnoMec, TecnoCooling, MecPump, ECTubi, Emilvapor, TecnoSpares. We are specialized in manufacturing of high pressure pumps, cleaning equipment, fittings, tubing, parts and accessories. In the year ended 31 December 2018, we reported gross revenue of EUR/€ 7.3 millions. It actually employs 32 workers over two factories located in Reggio Emilia, Italy with branches in USA and UAE.

### Quality control comes first.

Being a manufacturer we have full control on engineering and production. Stress test and double testing on a real misting pipeline is performed on all pumps delivered to our customers.

### Quick delivery is our mission.

We keep a large stock of spare parts and most common fittings and equipment are available for immediate delivery. Orders are processed within 24H, so that 90% of orders are shipped in 2 days.

### Full support, you will never be left alone.

Our staff is at your service to assist you in planning your installations for every application. Training courses, aftersale service and quickservicing are our strengths.

Company profile

Fruit & Vegetables department sanitization  
Disinfezione reparto frutta e verdura in un supermercato

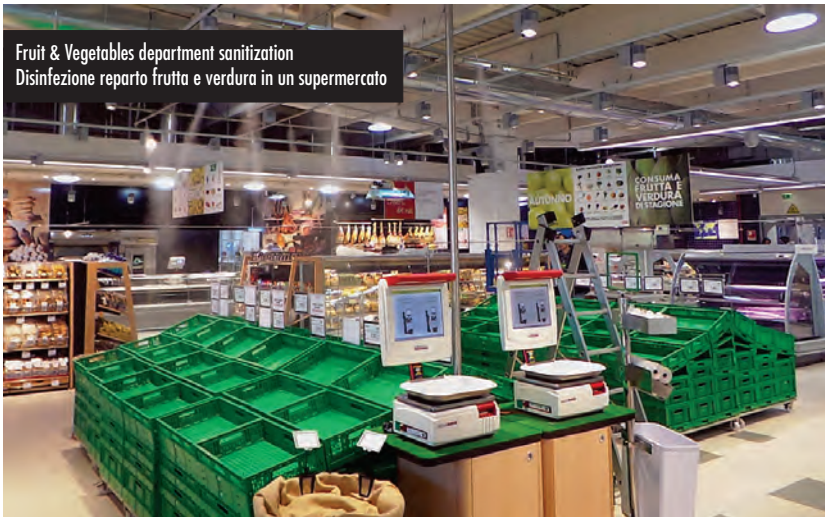

## Put our 40-year High Pressure experience to work for you.

We project and manufacture misting systems to suit every application, by using the best components and materials to guarantee long life running systems without troubles, weatherproof setting and with high performances. This is our daily work.

We are the sole company, who can provide fully and directly the production of FOG modules, which are the heart of each cooling system, from the design of hydraulic components on up to the manufacturing of patented anti-drip nozzles.

TecnoCooling systems are very efficient, with nearly costless maintenance, asking for low energy consumption and servicing.

## Our results demonstrate our quality level.

- \* Pump first maintenance is carried after 1500 working hours
- \* Two years warranty on all items
- \* Spare parts sold from 2005 to date: 1% of turnover

Our extremely versatile and modular solutions allow to build an entire misting system easily, saving on installation and planning costs.





**TecnoCooling** è uno dei più grandi costruttori di pompe ed accessori per micronebulizzazione con partner commerciali in cinque continenti.

Il vasto portfolio di marchi commerciali del gruppo include TecnoMec, TecnoCooling, MecPump, EC Tubi, Emilvapor, TecnoSpares. Siamo specializzati nella produzione di pompe alta pressione, impianti e macchine il lavaggio, raccordi, tubazioni, componenti ed accessori.

Il 2018 si è concluso con un fatturato complessivo del gruppo pari a 7.3 milioni di euro. Il gruppo impiega 32 dipendenti in due diversi stabilimenti situati in provincia di Reggio Emilia ed altri nelle filiali in USA e UAE.

#### Controllo qualità al primo posto.

In quanto costruttori abbiamo sempre il pieno controllo sulla progettazione e fabbricazione. Test di durata e doppio collaudo su una vera linea di nebulizzazione vengono effettuati su tutte le pompe acquistate dai nostri clienti.

#### Consegne veloci sono la nostra missione.

Grazie ad un magazzino ben fornito, ricambi, componenti e le apparecchiature standard sono sempre disponibili per consegna immediata. Gli ordini sono lavorati entro 24 ore ed il 90% delle commesse viene consegnato entro 2 giorni.

#### Supporto professionale, non sarete mai soli.

Il nostro staff è al vostro servizio per assistervi nella progettazione degli impianti per qualsiasi applicazione. Da sempre i corsi di formazione, il servizio assistenza e manutenzione sono i nostri punti di forza.

## TecnoCooling

leader mondiale nella produzione di sistemi di nebulizzazione

TecnoCooling offre oggi la più completa e ampia gamma di soluzioni per la micronebulizzazione presenti sul mercato. Lavoriamo con impegno ogni giorno per realizzare prodotti innovativi che ci permettono di essere il vostro punto di riferimento nel settore.

EUROJET ceiling radial fan misting system  
EUROJET ventilatore radiale nebulizzante a sospensione



Profilo aziendale

## 40 anni di esperienza nel settore al vostro servizio.

*Progettare e costruire sistemi di micronebulizzazione per ogni applicazione utilizzando i componenti migliori per garantirvi un funzionamento privo di inconvenienti nel tempo ed in condizioni avverse, è alla base del nostro lavoro.*

*Possiamo vantare di essere l'unica realtà produttiva in grado di progettare e costruire in proprio i "moduli FOG", cioè il "cuore" dei sistemi di nebulizzazione oltre che ai circuiti idraulici ed agli ugelli speciali antigoccia brevettati.*

*I sistemi TecnoCooling sono ultra-efficienti, funzionano a costi di gestione pressoché nulli e richiedono manutenzioni minime.*

## I risultati ottenuti dimostrano la qualità dei nostri prodotti.

\* 1500 ore di lavoro della pompa senza manutenzione

\* Due anni di garanzia sui prodotti (dettagli su [www.tecnocooling.com](http://www.tecnocooling.com))

\* Ricambi venduti dal 2005 ad oggi: 1% del valore fatturato

*Versatilità e soluzioni modulari consentono di realizzare in tutta facilità, sistemi di nebulizzazione per qualsiasi applicazione, risparmiando sui costi di installazione e progettazione.*

## DISINFECTION and DECONTAMINATION

TecnoCooling misting systems is one of the most effective solutions in the field of disinfection and decontamination thanks to the high coverage of atomized droplets, generated by 70 bar (1000 psi) pressure.

### FOCUS ON "COVID-19"

We recommend hydrogen peroxide, max. 3% with our mist systems to disperse sanitizing chemicals and disinfect surfaces.

Mist systems use high pressure spraying generating fine atomized droplets (see figure to the right) to ensure large areas and hard-to-reach corners and crevices are coated with disinfectant. This method is ideal for hidden surfaces high-touch point areas such as pallets, packaged goods, clothes, tools, shopping trolleys, baskets, bikes, motorbikes, ambulances, other vehicles.

Individuals decontamination and large areas decontamination is also possible by direct contact with the spray or air disinfection, by way of aerosol spray spread by our misting fans.

**Precautions on the use of H2O2:** Always use goggles and respirators, do avoid contact with eyes. Follow MSDS and instructions issued by chemicals manufacturer. Ventilation is needed when disinfection is completed. Rinse with fresh water after each use.

### DISINFECTION WITH HYDROGEN PEROXIDE

Decontamination from Covid-19 is made possible by using misted hydrogen peroxide in a concentration up to 3%.

- Approved by FDA to decontaminate compatible N95 Respirators
- Approved by IATA for disinfection of Public Areas
- Under normal conditions, it is extremely stable
- Loss of potency is less than 2% per year
- No residues, evaporation degrades it to water and oxygen
- Higher oxidation potential than chlorine dioxide



### APPLICATIONS DOMAINS

- Shopping malls
- Factories and warehouses
- Logistics, couriers, freight forwarders
- Hotels and resorts
- Hospitals
- Airports, bus and train stations
- Food processing industry
- Events, beaches, swimming pools

Hydrogen peroxide is active against a wide range of microorganisms, including bacteria, yeasts, fungi, viruses, and spores. It works by producing destructive hydroxyl free radicals that can attack membrane lipids, DNA, and other essential cell components

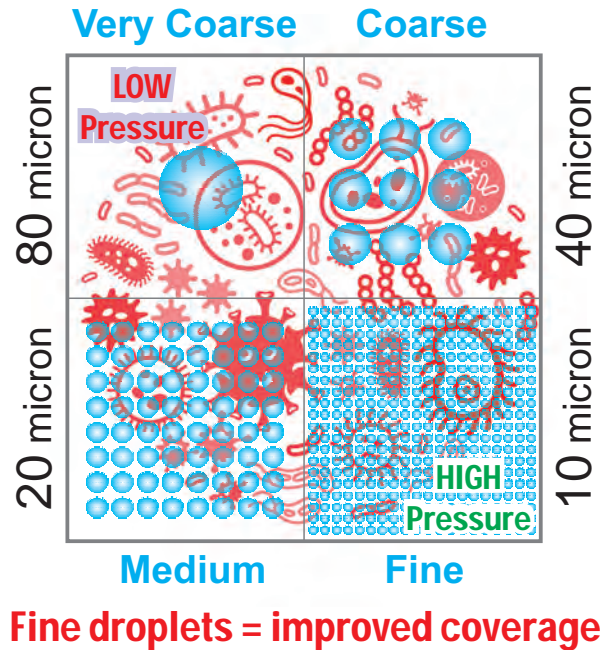

Influence of droplets size (picture for illustration purpose only)

### HOW IT WORKS

TecnoCooling misting system sprays an ultra light mist of water directly onto the items to be decontaminated. Due to their teeny dimensions, these small volatile water droplets can reach any vertical or horizontal surface with a very high coverage rate, they evaporate without wetting so much as other low pressure spraying systems.

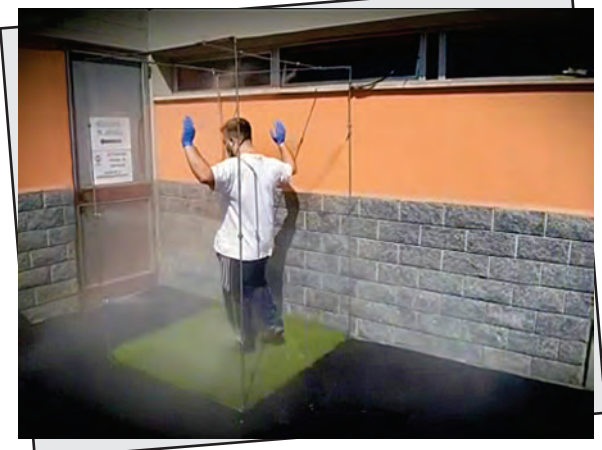

## DISINFEZIONE e DECONTAMINAZIONE

I nostri sistemi di micronebulizzazione sono la soluzione professionale ed efficiente per la decontaminazione. L'alta pressione a 70bar genera microgocce che avvolgono le superfici in modo altamente coprente.

### FOCUS SU "COVID-19"

Raccomandiamo di utilizzare con i nostri sistemi Perossido di Idrogeno in basse concentrazioni (max. 3%), disperdendo il prodotto sanificante per decontaminare superfici e ambienti. I sistemi di nebulizzazione ad alta pressione generano goccioline ultrafini (vedere figura a destra) che possono essere disperse su grandi aree ma anche raggiungere angoli e fessure ricoprendoli con uno strato omogeneo di sanificante. Questo sistema è l'ideale per superfici nascoste e ad alto contatto come pallets, materiale confezionato, abiti, attrezzature, carrelli per la spesa, cesti, bici, moto, ambulanze, auto ed altri veicoli. La decontaminazione individuale ma anche dell'aria in grandi aree, e' possibile per contatto diretto o spruzzo ad aerosol veicolato da ugelli e/o ventilatori.

**Precauzioni nell'uso di H2O2:** Indossare sempre dispositivi di protezione, occhiali e respiratore, evitare il contatto con gli occhi. Vanno seguite obbligatoriamente le istruzioni e SDS rilasciate dal produttore del prodotto chimico. Areare gli spazi dopo il trattamento. Risciacquare i circuiti con acqua pulita al termine di ogni uso.

### DISINFEZIONE CON PEROSSIDO DI IDROGENO

La decontaminazione da Covid-19 è resa possibile mediante l'uso di Perossido di Idrogeno in concentrazioni fino al 3%.

- **Approvazione FDA per decontaminazione di respiratori N95**
- **Approvazione IATA per disinfezione di Aree Pubbliche**
- **Estremamente stabile, in condizioni normali**
- **Perdita di potenziale inferiore al 2% annuo, facile da stoccare**
- **Nessun residuo, evapora trasformandosi in acqua e ossigeno**
- **Potere ossidativo superiore al Diossido di Cloro**



### CAMPI DI APPLICAZIONE

- **Centri commerciali**
- **Fabbriche e magazzini**
- **Logistica, corrieri, spedizionieri**
- **Hotel e villaggi turistici**
- **Ospedali, ambulatori**
- **Aeroporti, bus e stazioni ferroviarie**
- **Industria alimentare**
- **Eventi, spiagge, piscine**

Il perossido di idrogeno è attivo contro una vasta gamma di microrganismi, tra cui batteri, lieviti, funghi, virus e spore. Funziona producendo radicali liberi ossidrillici distruttivi che possono attaccare i lipidi delle membrane, il DNA e altri componenti cellulari essenziali.

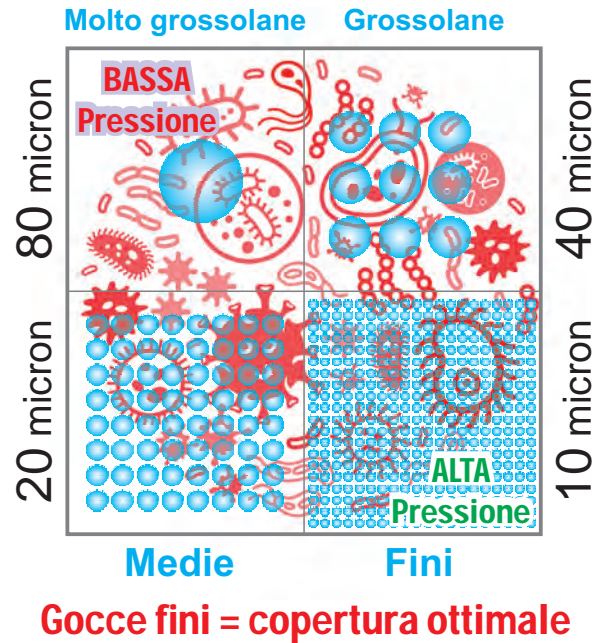

Efficienza e dimensione delle gocce (immagine puramente illustrativa)

### COME FUNZIONA

I nostri sistemi di nebulizzazione emettono una fine nebbia direttamente sugli oggetti da decontaminare. Queste volatili gocce possono raggiungere superfici verticali e orizzontali con un alto tasso di copertura, evaporando poi senza lasciarle troppo bagnate, come accadrebbe con un sistema a bassa pressione.



Esempio di schema di montaggio  
linea acciaio Inox  
Mounting layout example S.Steel line

Pompa/Pump:  
Evolution-Time KEM or DeltaKEM

## DISINFECTION/DECONTAMINATION ARCHWAYS / TUNNELS SISTEMA DISINFEZIONE/DECONTAMINAZIONE PORTALI/TUNNEL

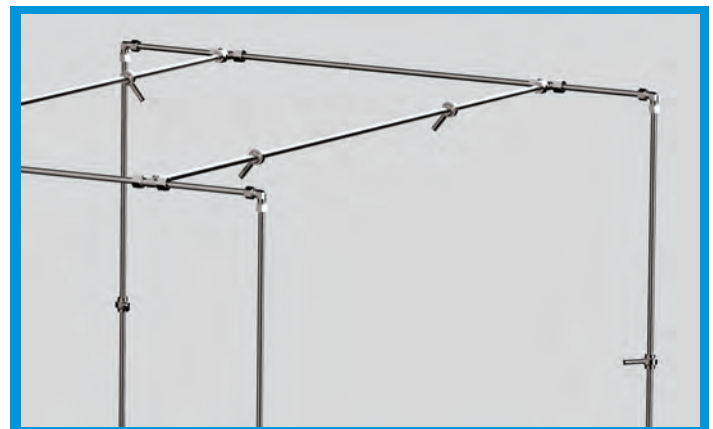
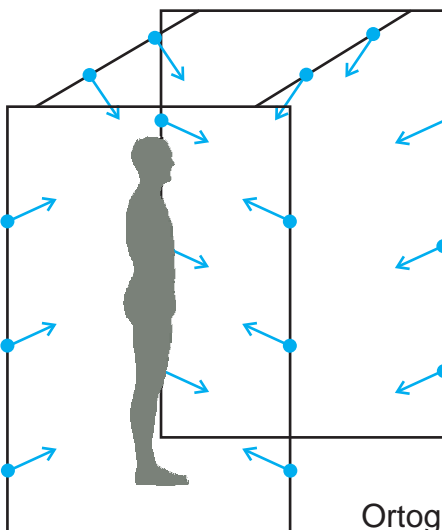
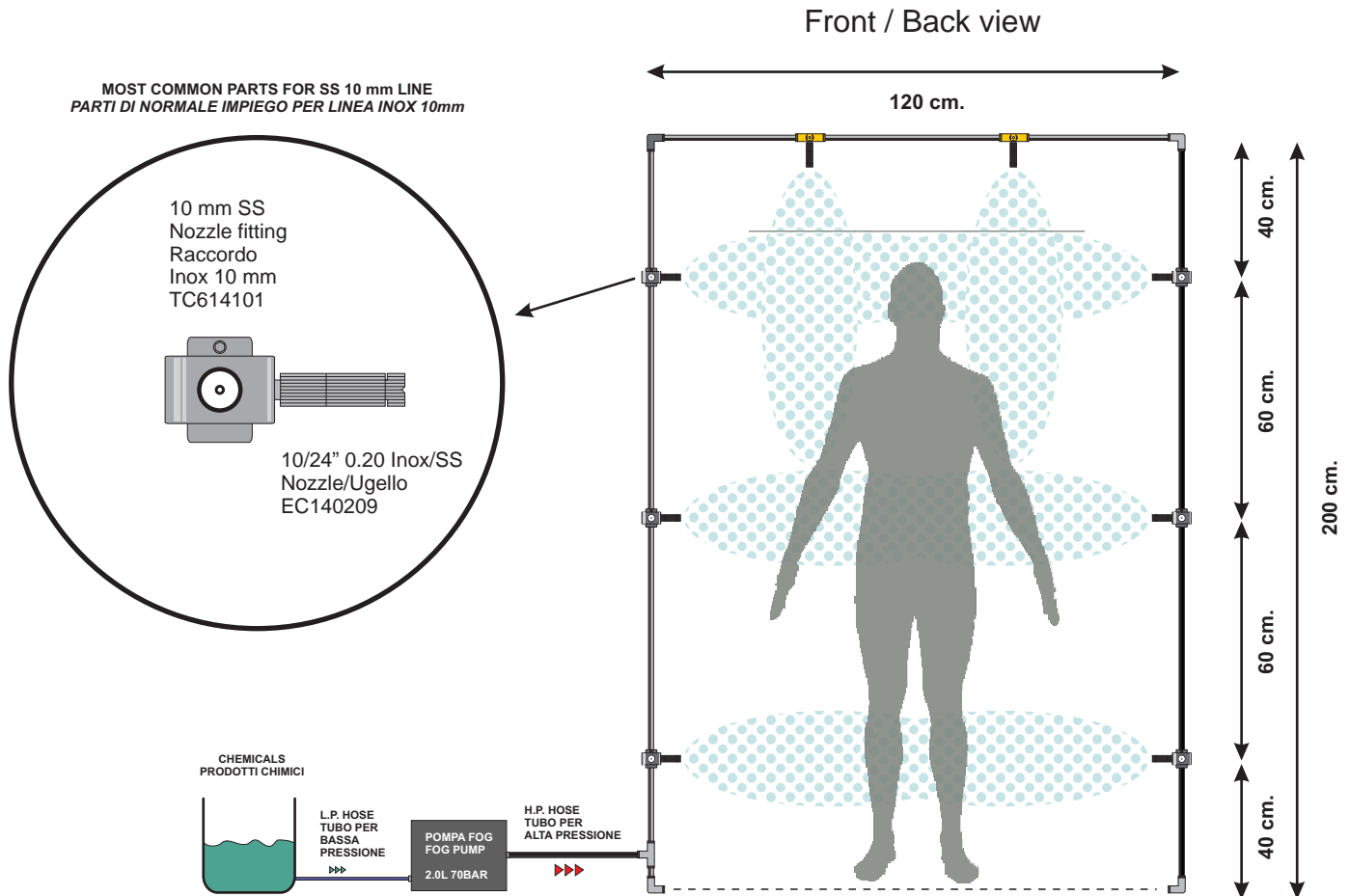

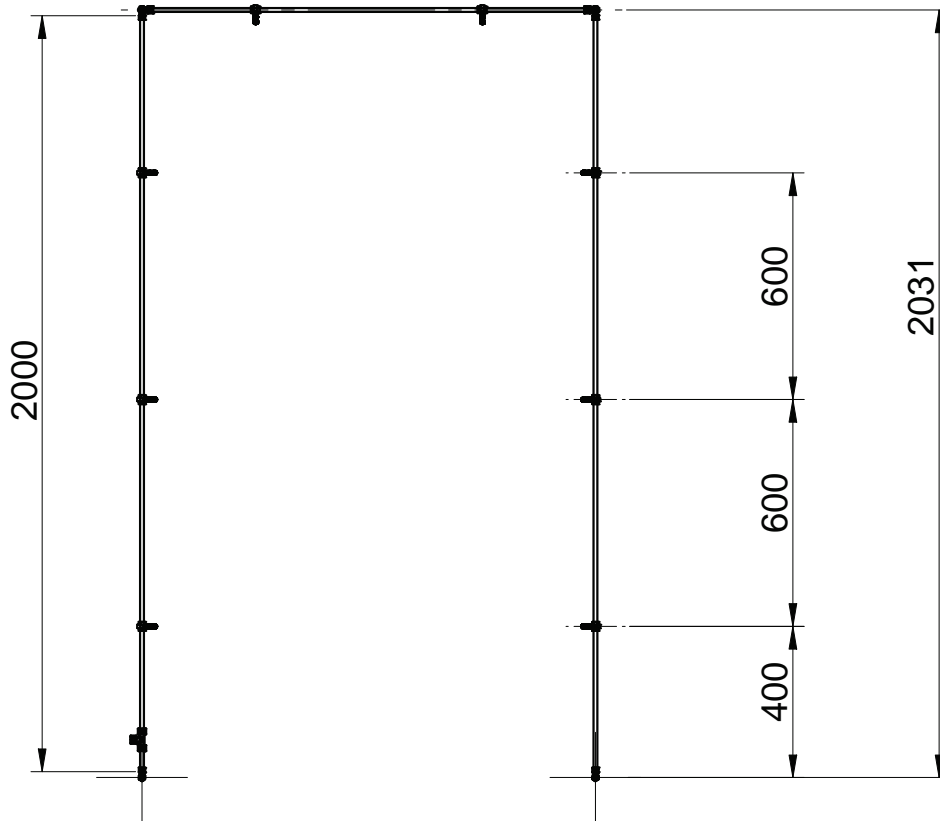

Front/Back view

Standard dimensions

Systems design and dimensions are fully customizable. Check pages 51-55 on our catalogue for the complete range of pipes, fittings, accessories.

*Le dimensioni e il design sono completamente personalizzabili. Consultate il ns catalogo alle pagg. 51-55 per la gamma completa di tubi, raccordi, Accessori.*

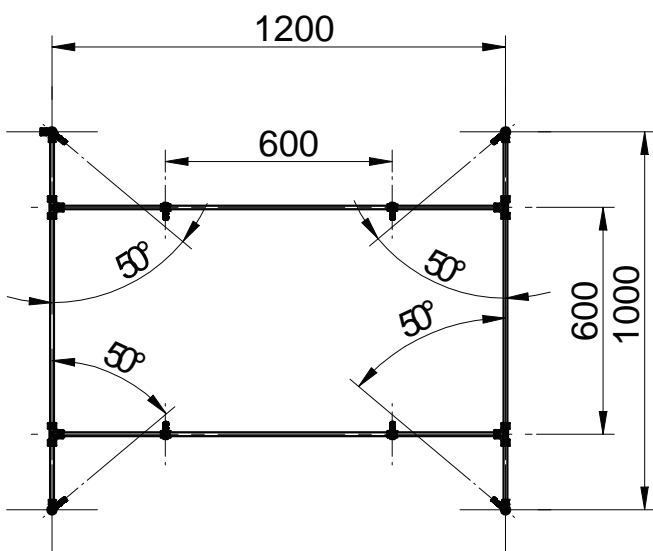

Top view

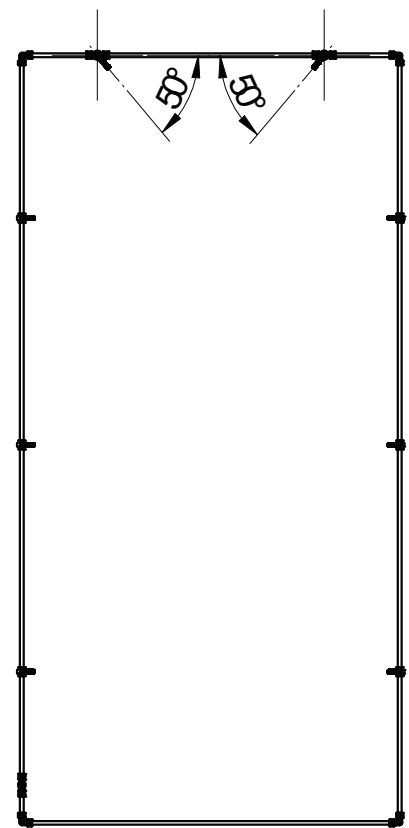

Left/Right sides view

## MOBI-COOL KEM

### Ventilatore nebulizzante autonomo



MOBI-COOL KEM è un ventilatore trasportabile ad effetto nebulizzante dotato di pompa e serbatoio integrati.

Grazie al sistema di pressurizzazione interno MOBI-COOL KEM è in grado di miscelare prodotti liquidi atomizzati al flusso di aria ventilata creando così un'azione sanificante in tutta l'area d'azione.

Finalmente un sistema di disinfezione facilmente trasportabile e senza installazioni fisse. MOBI-COOL KEM infatti è un ventilatore speciale, silenzioso, efficace, totalmente autonomo grazie al serbatoio interno di grande capacità che garantisce un'autonomia ottimale.

La silenziosità, pari ad un'emissione acustica inferiore ai 65 dB, è garantita dal motore elettrico a basso consumo QES, tecnologia studiata per le applicazioni in ambienti che necessitano di basse emissioni acustiche.

#### CARATTERISTICHE TECNICHE

- gruppo pompa professionale con testata alluminio
- pressione di lavoro: 70 bar
- 3 pistoni in ceramica ad alta resistenza
- sistema a portata variabile con by-pass interno
- valvola di sicurezza
- motore industriale autoventilato
- protezione termica
- serbatoio da 60 litri
- interruttore OFF/VENTILAZIONE/VENTILAZIONE+NEBULIZZAZIONE
- peso bilanciato, ruote e maniglia di movimentazione
- sensore di livello per prevenzione da funzionamento a secco
- costruito in conformità alle normative CE

Utilizzabile in Interni ed Esterni !

**QES:** le versioni dotate di motore silenziato QES sono particolarmente apprezzate dove il rumore non deve arrecare fastidio agli operatori e lavoratori.

**BPS:** tutte le versioni sono dotate di By-Pass System (circuito interno di By-pass), vale a dire un sistema di ricircolo che riduce il surriscaldamento della pompa e allo stesso tempo permette di raffreddarla. Questo sistema permette inoltre di evitare l'installazione di valvole di scarico a terra esterne.

#### APPLICAZIONI

Impieghi possibili: magazzini, locali pubblici, hotel, piscine, capannoni, officine, logistica, trasporti, industria alimentare e qualunque altro ambiente da sanificare.

Riempite il serbatoio, collegate la spina, accendete.

In un attimo un potente flusso d'acqua atomizzata sarà in grado di ricoprire con un velo di prodotto sanificante pavimenti, oggetti, merci, strumenti senza bagnarli in modo eccessivo.



Mobi-Cool Kem

- Facilmente movimentabile
- Getto nebulizzante
- Abbatte le polveri PM10

**Super silenzioso!**  
**Meno di 65 dB(A)**

Dimensions: WxHxP 580x2050x580 mm  
Weight: 50 Kg (with empty tank)

Dimensioni: h. 2050 x p. 580 x l. 580 mm  
Peso: 50 Kg a secco





## MOBI-COOL KEM

### Portable high pressure mist cooling fan

MOBI-COOL KEM is a stand-alone, high-pressure, low-noise misting fan with built-in pump and chemical tank.

Thanks to the built-in pressurization system, MOBI-COOL KEM is capable of mixing atomized liquids to the airflow, thus producing a disinfection effect all around.

Finally! A portable disinfection system without fixed installations. MOBI-COOL KEM is really a special atomizing fan, quiet, effective, fully autonomous with a high capacity tank that guarantees a great autonomy.

MOBI-COOL KEM is quiet, its electrical QES motor and pump are low noise, less than 65 DB noise emission, thanks to a low consumption technology designed for applications in environments requiring low noise emissions.

#### TECHNICAL FEATURES

- professional high pressure pump with aluminium head
- working pressure: 70 bar
- 3 heavy duty ceramic pistons
- variable flow rate, built-in by-pass
- safety valve
- heavy duty self-ventilated industrial motor
- thermal overload protection
- 60 liters (15.85 Gallons) tank
- OFF/FAN-ON/FAN AND MISTING ON switch
- weight balanced, wheels and handle for easy displacement
- electric float switch level controller to protect pump against dry running
- manufactured in compliance with CE regulations

• Easily transportable  
• Lowers temperature  
• Absorbs dust and PM10

**Super Quiet Engine!**  
**Less than 65 dB(A)**

**QES:** units supplied with QES low noise motors (Quiet Engine System) are peculiarly preferred where noise may disturb your operators and workers.

**BPS:** all units are equipped with By-Pass System (built-in by-pass valve), recirculating the liquid inside the pump, preventing from pump overheating. Fog systems driven by BPS fog pumps do not require any drain valves to empty the pipe so that no water is wasted on the ground.

#### USES

Warehouses, public places, hotels, swimming pools, factories, shopping malls, logistics, shipping, food industry and any other area to be sanitized.

Fill the tank, connect the plug, switch on. in a while a powerful flow of atomized liquid will be able to cover floors, objects, goods and tools with a veil of sanitizing product without wetting them excessively.

#### Mobi-Cool KEM 1450

Code Codice	Pressure Pressione		Output Portata		Power Potenza		Running Autonomia		Volt	Nozzles Ugelli	Price Prezzo
	Bar	psi	l/m	gpm	W	Ah	min/minutes	50Hz			
TC600090	70	1000	1.6	0.42	590	2.9	37	230	20 x 0.20	-	

MobiCool KEM 1450 with 4P motor, 1450 RPM, noise level 65dB (average)

MobiCool KEM 1450 motore elettrico 4P, 1450 RPM, rumorosità 65dB (media)

#### Fan details



Oscillating fan - Ventilatore Oscillante

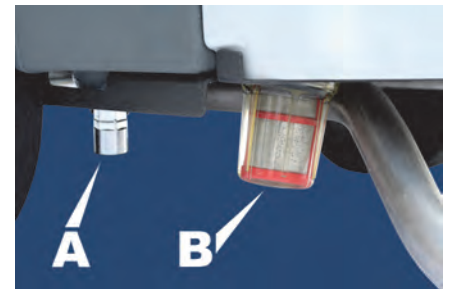

A) Drain - Scarico  
B) Cleanable filter - Filtro lavabile

#### Dettagli nebulizzatore



For Indoor & Outdoor use!



download video

Serie EVOLUTION "TIME" KEM  
Decontaminazione, polveri e odori



Misting pump 70bar - 1000psi  
from 8 to 75 nozzles  
230V or 120V - 50 or 60Hz

IT - Questa serie di pompe professionali rappresenta la soluzione ideale, con un elevato standard di qualità e sicurezza, per tutte le esigenze di realizzazione di impianti di nebulizzazione professionali per l'abbattimento di odori, polveri e la diffusione di prodotti chimici per la decontaminazione. Il gruppo pompante è realizzato con materiali resistenti alla corrosione come Nickel, Ottone, Acciaio Inox, Alluminio, Viton, garantendo un funzionamento privo di problemi anche nelle condizioni più avverse. Il temporizzatore digitale integrato permette di dosare l'intensità dell'effetto nebulizzante, quindi di gestire al meglio il rendimento dell'impianto con notevoli benefici sui consumi e risparmi fino al 70%. Noto anche la silenziosità sui modelli dotati di motore elettrico a basso consumo QES, tecnologia studiata per le applicazioni in ambienti che necessitano di basse emissioni acustiche. Il drenaggio a recupero interno BPS evita gli sprechi d'acqua, di prodotto chimico e consente un migliore raffreddamento del gruppo pompante. Portate da 1 a 6 l/min, con motore elettrico monofase.



Evolution Time KEM

CARATTERISTICHE TECNICHE

- gruppo pompa professionale con testata nickel
- guarnizioni e tenute di pompaggio in Viton®
- 3 pistoni con rivestimento ceramico ad alta resistenza
- pressione di lavoro: 70 bar
- sistema a portata variabile con by-pass interno
- valvola di sicurezza
- manometro in glicerina
- pressostato di sicurezza per prevenzione da funzionamento a secco
- 2 elettrovalvole a solenoide in linea, 230V-50Hz
- motore industriale monofase 2,0 HP, 1450 RPM autoventilato
- interruttore ON/OFF e protezione termica
- temporizzatore digitale a 3 funzioni programmabile
- carter chiuso in metallo con piedi antivibranti in gomma
- basso livello di rumorosità: 60 dB(A)
- costruito in conformità alle normative CE

Resistenza alla corrosione:  
● Testata NICKEL  
● Sistema di tenuta: VITON

Per l'abbattimento di POLVERI e ODORI



QES: le versioni dotate di motore silenzioso QES sono particolarmente apprezzate nel campo del "resort" (villaggi turistici, piscine, bar, ristoranti, hotel) dove il rumore non deve arrecare fastidio agli ospiti.

TIME: tutte le versioni sono dotate di temporizzatore digitale TIME e permettono di modulare il funzionamento del sistema, gestendo diverse situazioni climatiche, come ad esempio le ore diurne e la sera, con notevole risparmio sui consumi.

BPS: tutte le versioni sono dotate di By-Pass System (circuito interno di By-pass), vale a dire un sistema di ricircolo dell'acqua che evita il surriscaldamento della pompa e allo stesso tempo permette di raffreddarla. Questo sistema permette inoltre di evitare l'installazione di valvole di scarico a terra esterne.

EVOLUTION TIME KEM - 230V 50Hz or 60Hz - 1450 RPM

Code Codice	Pressure Pressione		Ugelli* Nozzles*		Output lpm Portata l/min		Output gpm Portata g/min		Power Potenza		Price Prezzo
	bar	psi	50Hz	60Hz	50Hz	60Hz	50Hz	60Hz	W	A (50Hz)	
EC308056	70	1000	8 - 12	10 - 15	1	1.2	0.26	0.32	550	2.8	
EC308050	70	1000	20 - 30	24 - 36	2.5	3	0.66	0.79	720	3.3	
EC308058	70	1000	30 - 40	36 - 48	3	3.6	0.78	0.95	815	3.7	
EC308051	70	1000	40 - 50	48 - 60	4	4.8	1.06	1.27	900	4.1	
EC308052	70	1000	50 - 75	60 - 90	6	7.2	1.59	1.90	1250	5.7	

\* Ugelli da 0.20 mm (0.008" Nozzles)



Dimensioni: l. 490 x p. 410 x h. 300 mm  
Peso: 33 Kg.  
Dimensions: l. 490 w. 410h. 300 mm  
Weight: 33 Kg.

## EVOLUTION "TIME" KEM series

### Decontamination, Dust, Odor suppression

**EN** - These series of professional high pressure pumps are the suitable solution with high quality and safety standard for all requirements to build professional misting systems for **dust and odor suppression** or **sanitizing by chemicals spreading**. Pump parts are made by oxidation resistive materials like **Nickel, Brass, Stainless Steel, Aluminium, Viton**, assuring troubleless operation and long durability. Our **built-in digital timer** offers full control of the efficiency of the fogging system by direct adjustment of the frequency of mist spray increasing the advantages on water and energy consumption with savings up to 70%.

QES electrical motors assure the full efficiency with lowest power consumption and **low noise** operation. QES units are the best solution for applications where noise is a matter of disturb. **BPS internal drain system** avoids to waste water and chemicals during drain cycles. Flow rates ranging from 1 to 6 l/min, single-phase electric motor.

#### TECHNICAL FEATURES

- professional high pressure pump, **nickel head**
- **Viton®** seals
- 3 **heavy duty ceramic coated** plungers
- working pressure 70 bar
- variable flow rate, **built-in bypass**
- safety valve
- glycerin filled pressure gauge
- 2 in line mounted solenoid 230V-50Hz
- heavy duty industrial motor, single phase 2.0 HP, 1450 RPM, self ventilated
- ON-OFF switch and thermal overload protection
- 3 functions programmable cyclic digital timer
- wheatherproof steel skid cover on antivibration rubber feet
- pressure switch to protect pump against dry running
- noise level: 60 dB(A) (average)
- manufactured in compliance with CE regulations

**QES:** units supplied with QES low noise motors (Quiet Engine System) are peculiarly preferred in resorts, swimming pools, bars, restaurants, hotels, where noise may disturb your guests.

**TIME:** all units supplied with digital timer allow to modulate the operation of the system, regulating the mist spray according to day-night cycles and therefore saving energy and water, obtaining an optimal ambient temperature.

**BPS:** all units are equipped with By-Pass System (built-in by-pass valve), recirculating the water inside the pump, preventing from pump overheating. Fog systems driven by BPS fog pumps do not require any drain valves to empty the pipe so that no water is wasted on the ground.

The best in DUST & ODOR suppression

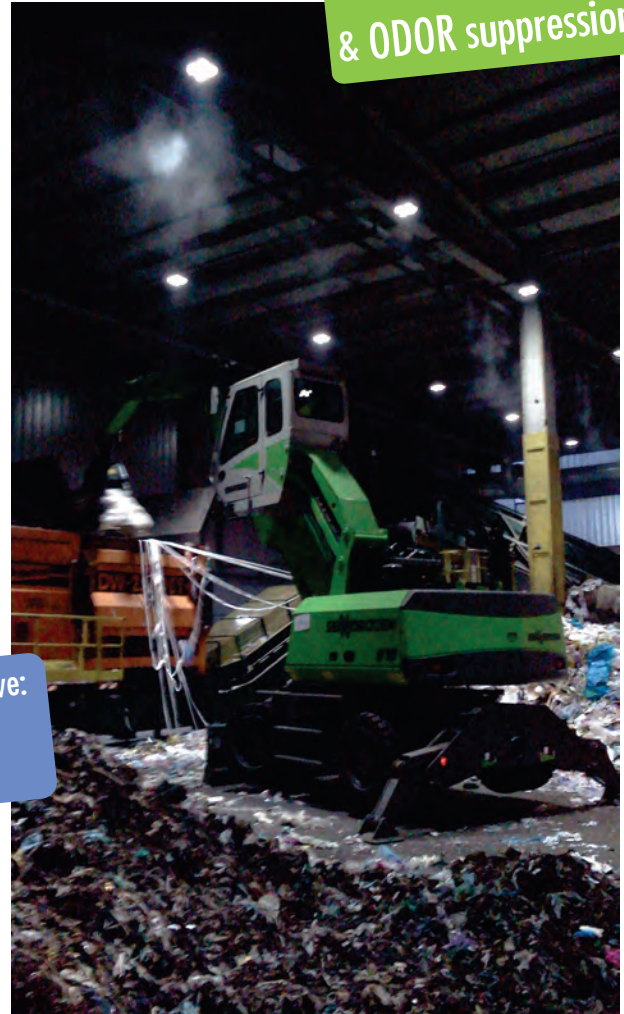

Oxidation/Chemical resistive:  
 ● NICKEL pump head  
 ● VITON seals



Accessori consigliati  
 Recommended accessories

## Serie DELTAKEM inox pompa inox per prodotti aggressivi

Questa serie di **pompe professionali** in **acciaio inox** rappresenta la soluzione ideale per la realizzazione di sistemi di nebulizzazione con portate di 5 litri/minuto, con **alimentazione elettrica monofase**. Quando impiegate unitamente ai ns. tubi ed accessori in acciaio inox permettono la realizzazione di impianti in grado di spruzzare una vasta gamma di prodotti chimici aggressivi.

Il **controller digitale** integrato permette gestire lo **scarico automatico** e di monitorare la pressione di lavoro e la mancanza acqua.

Il **sistema di sicurezza SSC** previene il pericolo di allagamenti bloccando la pompa in caso di guasti sulla linea.

## DELTAKEM S.Steel series

### S.S. pump for aggressive chemicals

These series of **professional high pressure S.Steel pumps** are the suitable solution with high quality and safety standard for all requirements to build professional misting systems 5 liters/min flow rate with **single-phase electric motor**. Misting systems assembled with these pumps and our S.Steel pipes and fittings are capable of spraying a wide variety of aggressive chemicals.

Our built-in **digital controller** allows to operate an automatic **drain valve** and to monitor water supply and working pressure. **SSC safety features** avoid accidental flooding by stopping the pump in case of leakages.

#### CARATTERISTICHE TECNICHE

- gruppo pompa professionale in acciaio inox
- meccanismo a 3 pistoni con rivestimento ceramico ad alta resistenza
- pressione di lavoro: 70 bar
- valvola di sicurezza
- elettrovalvola di scarico alta pressione, 24V DC inox
- elettrovalvola in ingresso, 24V DC inox
- tubo di scarico in gomma
- pressostato alta pressione
- motore industriale monofase 3 HP, a 1450 RPM ventilato
- protezione termica
- interruttore ON/OFF
- controller con display digitale
- carter in acciaio inox con piedi antivibrazione in gomma
- basso livello di emissioni acustiche
- spegnimento automatico per mancanza acqua
- spegnimento automatico in caso di perdita e guasti alle tubazioni
- costruita in conformità alle normative CE

DELTA SS KEM -230V 50Hz or 60Hz - 1450 rpm

Code Codice	Pressure Pressione		Ugelli* Nozzles*		Output lpm Portata l/min		Output gpm Portata g/min		Power Potenza		Price Prezzo
	bar	psi	50Hz	60Hz	50Hz	60Hz	50Hz	60Hz	W	A (50Hz)	
TC307315	70	1000	55 - 65	66 - 78	5	6	1.32	1.58	1780	7.1	

\* Ugelli da 0.20 mm (0.008" Nozzles)



Misting pump 70bar - 1000psi  
from 55 to 65 nozzles  
230V-50Hz or 60Hz



DeltaKEM S.Steel

- nuovo sistema di sicurezza SSC
- new SSC system safety control

Heavy Duty  
misting pumps!

S.STEEL  
Pump & Parts

COMPONENTI  
in acciaio Inox

#### TECHNICAL FEATURES

- heavy-duty high pressure pump
- 3 ceramic plungers, S.Steel head
- working pressure: 70 bar
- safety valve
- high pressure S.Steel solenoid drain valve 24V DC
- S.Steel inlet solenoid valve 24V DC
- drain hose
- high pressure switch
- heavy duty ventilated industrial motor single-phase 3 HP, 1450 RPM
- ON-OFF switch
- digital display controller
- S.Steel skid on antivibration rubber feet
- low noise
- automatic switch-off if dry running is detected
- automatic switch-off if no pressure (leakage) is detected
- manufactured in compliance with CE regulations

SSC  
System Safety Control

Dimensioni: l. 950 x p. 550 x h. 450 mm  
Peso: 35 Kg  
Dimensions: l. 950 w. 550 h. 450 mm  
Weight: 35 Kg

## Standard 3/8" Push-In fittings and tubing for POLYAMIDE line

### Raccordi 3/8" ad innesto rapido e tubi linea POLYAMIDE

Cod.	Description	Cod.	Description
	<b>TC300001</b> Raccordo portaugello ad innesto 3/8" con 1 foro 10/24" 3/8" 3/8" Fitting for nozzle 10/24"		<b>EC400021</b> Tubo alta pressione PA12-RIGID 3/8" in rotolo 25 mt. - BIANCO 3/8" nylon coil pipe 25 m PA12-RIGID - WHITE
	<b>TC300002</b> Raccordo per 2 ugelli da 10/24" ad innesto 3/8" 120 3/8" Fitting for 2 nozzles 10/24" 120		<b>EC400022</b> Tubo alta pressione PA12-RIGID pretagliata 80 cm - BIANCO 80 cm in length nylon pipe 3/8" PA12-RIGID - WHITE
	<b>TC300012</b> Raccordo per 2 ugelli da 10/24" ad innesto 3/8" 180 3/8" Fitting for 2 nozzles 10/24" 180		<b>EC400027</b> Graffa fissatubo da 3/8" inox con guarnizione BIANCA S.Steel clamp for 3/8" tubing WHITE
	<b>TC300003</b> Raccordo unione ad innesto 3/8" 3/8" tube coupling		<b>EC400001</b> Tubo alta pressione PA12-RIGID 3/8" in rotolo 25 mt. - NERO 3/8" nylon coil pipe 25 mt. PA12-RIGID - BLACK
	<b>TC300013</b> Raccordo portaugello ad innesto di fine linea 3/8" End Fitting for 1 nozzle		<b>EC400004</b> Tubo alta pressione PA12-RIGID 3/8" in rotolo 50 mt. - NERO 3/8" nylon tubing in coil form 50 m PA12-RIGID - BLACK
	<b>TC300004</b> Raccordo a Tee ad innesto 3/8" 3/8" T Fitting		<b>EC400003</b> Tubo alta pressione PA12-RIGID 3/8" in rotolo 100 mt. - NERO 3/8" nylon tubing in coil form 100 m PA12-RIGID - BLACK
	<b>TC300005</b> Raccordo curva 90 ad innesto 3/8" 3/8" L Fitting		<b>EC400002</b> Tubo alta pressione PA12-RIGID 3/8" pretagliata 80 cm - NERO 80 cm in length nylon pipe 3/8" PA12-RIGID - BLACK
	<b>TC300026</b> Raccordo inizio 3/8" tubo x 1/4" BSP-T 1/4" BSP-T male connector for 3/8" tube		<b>EC400007</b> Graffa fissatubo da 3/8" inox con guarnizione - NERA S.Steel clamp for 3/8" tubing - BLACK
	<b>TC300010</b> Adattatore Tubo-Ugello tubo 3/8"- ugello 10/24" 3/8" tube to nozzle adaptor		<b>EC400010</b> Pinza tagliatubi in metallo per tubi dia. max. 1/2" High quality metallic tubing cutter
	<b>TC300009</b> Tappo di fine linea da 3/8" 3/8" end plug		<b>TC400009</b> Valvola a sfera di intercettazione con raccordi innesto 3/8" - 80 bar 3/8" On/Off slip lock Valve - 1150 psi



**NOXIDE**  
Oxidation-Acids  
Resistive coating

**PATENTED - BREVETTATI**  
Adaptive teeth - Pulsation compatible  
Inserimento facilitato - Adatti per timers

- 3/8" tubing = Ø 9,52 mm • Operating pressure - Pressione nominale: 100 bar (1500 psi)
- Burst pressure - Pressione max. (scoppio): 300 bar (4350 psi)
- Max. misting line length - Lunghezza massima linea: 90 m (300 Ft)
- Max. flow rate - Portata massima linea: 11 l/min (2.9 Gpm)

## Standard 3/8" Push-In fittings and tubing for POLYAMIDE line

Raccordi 3/8" ad innesto rapido e tubi linea POLYAMIDE

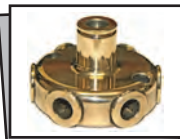
Cod.	Description
 EC300006	Raccordo a croce 4 vie ad innesto 3/8" 3/8" four way (X) cross fitting
 EC300008	Connettore per 6 ugelli ad ombrello ad innesto 3/8" 3/8" x 6 nozzles misting umbrella
 EC300030	Connettore per linea a stella 1 IN + 6 OUT x 3/8" Tube connector 1 to 6 for 3/8" pipe



## Special Push-In fittings and tubing for POLYAMMIDE line

Raccordi speciali e tubi per linea POLYAMMIDE

Cod.	Description
 EC300011	Raccordo inizio 3/8" tubo x 3/8"NPT 3/8" Male connector for 3/8" tube
 EC300014	Raccordo di unione diritta 1/2" 1/2" Tube coupling
 EC300015	Giunzione ridotta 1/2" x 3/8" 1/2" - 3/8" adaptor
 EC300016	Raccordo innesto a T 1/2" 1/2" T Fitting

Cod.	Description
 EC300017	Raccordo innesto T 1/2" - 3/8" - 1/2" 1/2" - 3/8" - 1/2" T Fitting
 EC300018	Tappo di fine linea 1/2" 1/2" end plug
 EC300021	Raccordo inizio 1/2" tubo x 1/2" 1/2" male connector for 1/2" tube
 EC400008	Graffa fissatubo da 1/2" in acciaio con guarnizione Clamp for 1/2" tubing
 EC400006	Tubo alta pressione PA12-RIGID in rotolo 25 mt. 1/2" nylon coil pipe 25 m PA12-RIGID

**NOXIDE**  
Oxidation-Acids  
Resistive coating

- 1/2" tubing = Ø 12,5 mm
- Operating pressure - Pressione nominale: 100 bar (1500 psi)
- Burst pressure - Pressione max. (scoppio): 300 bar (4350 psi)

## 10 mm STAINLESS STEEL PIPES and fittings

Linea ACCIAIO INOX 10 mm e raccordi



Cod.	Description
 TC614101	Portaugello INOX 10mm - 1 foro 10/24unc/2B S.Steel 10mm Nozzle holder - 1 hole 10/24
 TC614102	Portaugello INOX 10mm - 2 fori 10/24unc/2B 180 S.Steel 10mm Nozzle holder - 2 holes 10/24 180
 TC614103	Portaugello INOX 10mm - 2 fori 10/24unc/2B 120 S.Steel 10mm Nozzle holder - 2 holes 10/24 120
 TC614120	Raccordo a T INOX (10 x 10 x 10 mm) S.Steel Tee fitting (10 x 10 x 10 mm)
 TC614121	Raccordo Curva 90 INOX (10 x 10 mm) S.Steel Union Elbow (10 x 10 mm)
 TC614122	Giunzione femmina INOX (BSP 1/4"F x 10mm) S.Steel Union - female connector (BSP 1/4"F x 10mm)
 TC614123	Giunzione tubo 10 mm INOX (10 x 10 mm) Union - pipe connector (10 x 10 mm)
 TC614124	Giunzione tubo 12-10 mm INOX (12 x 10 mm) Union - pipe connector (12 x 10 mm)
 TC614125	Raccordo a croce INOX 4 vie 10mm S.Steel 10mm four way (X) cross fitting



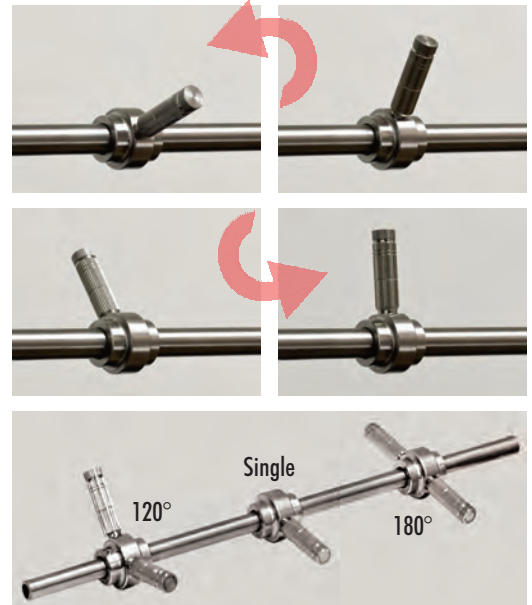



Adjustable fittings - Raccordi orientabili



## 10 mm STAINLESS STEEL PIPES and fittings

Linea ACCIAIO INOX 10 mm e raccordi

**INOX**  
Oxidation-resistive  
**S. STEEL**

Cod.	Description
 TC614127	Giunzione maschio INOX (BSP 1/4" M x 10mm) S.Steel Union - male connector (BSP 1/4" M x 10mm)
 TC614130	Giunzione maschio INOX (BSP 1/8" M x 10mm) S.Steel Union - male connector (BSP 1/8" M x 10mm)
 TC614126	Tappo di chiusura INOX per raccordi 10mm S.Steel end plug for 10mm fittings
 TC614131	Tappo INOX con foro 10/24" per raccordi 10mm S.Steel end plug with 10/24" hole for 10mm fittings
 TC614129	Busta 50 pz. OR Viton ricambio portaugello Inox 10mm Viton O-Rings for 10mm SS nozzle fitting - 50 pcs. bag
 TC614132	Busta 50 pz. Vite grano 3x3 portaugello Inox 10mm S.Steel 3mm screw for 10mm SS nozzle fitting - 50 pcs. bag
 TC614133	GUARNIZIONE Raccordi INOX D.10 L/S *FKM* FKM gasket for 10mm SS fittings

**Installazione raccordi orientabili**  
Adjustable fittings installation

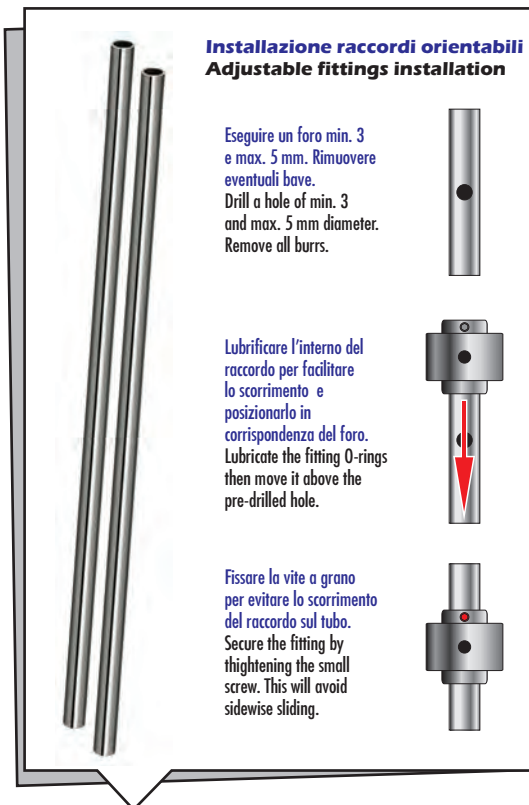

Eeguire un foro min. 3 e max. 5 mm. Rimuovere eventuali bave.  
Drill a hole of min. 3 and max. 5 mm diameter. Remove all burrs.

Lubrificare l'interno del raccordo per facilitare lo scorrimento e posizionarlo in corrispondenza del foro. Lubricate the fitting O-rings then move it above the pre-drilled hole.

Fissare la vite a grano per evitare lo scorrimento del raccordo sul tubo. Secure the fitting by tightening the small screw. This will avoid sidewise sliding.

Cod.	Description
TC713100	Tubo in acciaio INOX 10x1 mm : 100cm S.Steel pipe 10x1mm : 100cm
TC713200	Tubo in acciaio INOX 10x1 mm : 200cm S.Steel pipe 10x1mm : 200cm
TC713300	Tubo in acciaio INOX 10x1 mm : 300cm S.Steel pipe 10x1mm : 300cm

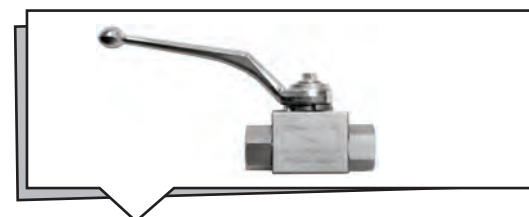

Cod.	Description
EC400013	Valvola a sfera INOX FF G 1/4" BSP Ball valve FF 1/4 BSP - S.Steel

- Tubazione 10x1 mm - 10x1 mm tubing
- Pressione nominale - Operating pressure: 100 bar (1450 psi)
- Pressione max. consentita - Max allowed pressure: 130 bar (1890 psi)
- Coppia di serraggio standard filetti e anelli conici: 85 Nm
- Standard tightening torque for threads and ferrules: 85 Nm















## 12 mm STAINLESS STEEL PIPES and fittings

Linea ACCIAIO INOX 12 mm e raccordi

**INOX**  
Oxidation-resistive  
**S. STEEL**

Cod.	Description
 TC614201	Portaugello INOX 12mm - 1 foro 10/24unc/2B S.Steel 12mm Nozzle holder - 1 hole 10/24
 TC614202	Portaugello INOX 12mm - 2 fori 10/24unc/2B 180° S.Steel 12mm Nozzle holder - 2 holes 10/24 180°
 TC614220	Raccordo a T INOX (12 x 12 x 12 mm) S.Steel Tee fitting (12 x 12 x 12 mm)
 TC614221	Raccordo Curva 90 INOX (12 x 12 mm) S.Steel Union Elbow (12 x 12 mm)
 TC614222	Giunzione femmina INOX (BSP 3/8"F x 12mm) S.Steel Union - female connector (BSP 3/8"F x 12mm)
 TC614223	Giunzione tubo 12 mm INOX (12 x 12 mm) Union - pipe connector (12 x 12 mm)
 TC614224	Giunzione tubo 15-12 mm INOX (15 x 12 mm) Union - pipe connector (15 x 12 mm)
 TC614225	Raccordo a croce INOX 4 vie 12mm S.Steel 12mm four way (X) cross fitting
 TC614226	Tappo di chiusura INOX per raccordi 12mm S.Steel end plug for 12mm fittings
 TC614229	Busta 50 pz. OR Viton ricambio portaugello Inox 12mm Viton O-Rings for 12mm SS nozzle fitting - 50 pcs. bag
 TC614231	GUARNIZIONE Raccordi INOX D. 12 L/S *FKM* FKM gasket for 1mm SS fittings

### Raccordi orientabili - Adjustable fittings

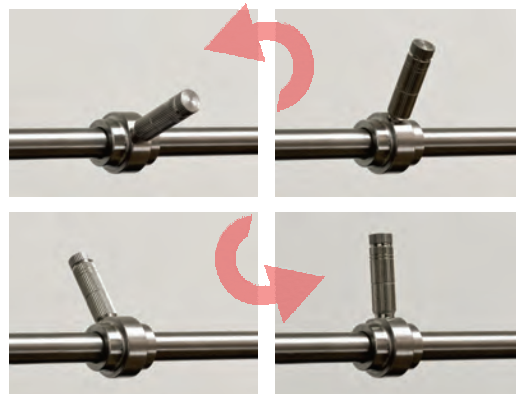

Cod.	Description
TC714100	Tubo in acciaio INOX 12x1 mm : 100cm S.Steel pipe 12x1mm : 100cm
TC714200	Tubo in acciaio INOX 12x1 mm : 200cm S.Steel pipe 12x1mm : 200cm

### Installazione raccordi orientabili Adjustable fittings installation

Eseguire un foro min. 3 e max. 5 mm. Rimuovere eventuali bave.  
Drill a hole of min. 3 and max. 5 mm diameter. Remove all burrs.

Lubrificare l'interno del raccordo per facilitare lo scorrimento e posizionarlo in corrispondenza del foro.  
Lubricate the fitting O-rings then move it above the pre-drilled hole.

Fissare la vite a grano per evitare lo scorrimento del raccordo sul tubo.  
Secure the fitting by tightening the small screw. This will avoid sidewise sliding.

- Tubazione 12x1 mm - 12x1 mm tubing
- Pressione nominale - Operating pressure: 100 bar (1450 psi)
- Pressione max. consentita - Max allowed pressure: 130 bar (1890 psi)
- Coppia di serraggio standard filetti e anelli conici: 120 Nm
- Standard tightening torque for threads and ferrules: 120 Nm

CLEANABLE NOZZLES and ACCESSORIES

UGELLI NEBULIZZATORI e ACCESSORI



TCN 10/24" Ugello ripulibile Noxide/acciaio inossidabile - TCN 10/24" type Noxide/S.Steel Nozzle

Testata e deflettore estraibile in acciaio inox per assicurare un ottima pulizia

With Stainless Steel head and impeller plate, which is able to be taken apart for cleaning

Con valvola antigoccia e filtro da 25 micron - With anti-drip check valve and 25 micron filter

Cod.	Item No.	Orifice	Orifice	Anti-drip type	
EC130159		0.15mm	.006"	NBR	55
EC130209		0.20mm	.008"	NBR	55
EC130309		0.30mm	.012"	NBR	55
EC130409		0.40mm	.015"	NBR	55
EC130509		0.50mm	.020"	NBR	55

**NOXIDE**  
Oxidation-Acids  
Resistive coating

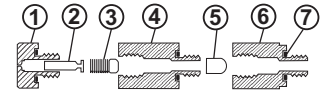

TCN with FILTER



TCN 10/24" Ugello ripulibile completamente in acciaio inossidabile - TCN 10/24" type Stainless Nozzle

Testata e deflettore estraibile in acciaio inox per assicurare un ottima pulizia

With Stainless Steel head and impeller plate, which is able to be taken apart for cleaning

Con valvola antigoccia e filtro da 25 micron - With anti-drip check valve and 25 micron filter

Cod.	Item No.	Orifice	Orifice	Anti-drip type	
EC140159		0.15mm	.006"	Viton	55
EC140209		0.20mm	.008"	Viton	55
EC140309		0.30mm	.012"	Viton	55
EC140409		0.40mm	.015"	Viton	55
EC140509		0.50mm	.020"	Viton	55

**INOX**  
Oxidation-resistive  
S. STEEL

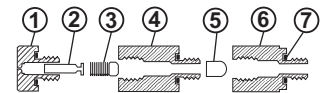

TCN with FILTER

1-Testina 2-Pistoncino antigoccia 3-Molla antigoccia 4-Corpo 5-Filtro 6-Corpo 7-O-ring  
1-Head 2-Anti-drip piston 3-Anti-drip spring 4-Body 5-Filter 6-Body 7-O-ring



TCN 10/24" Ugello ripulibile noxide/acciaio inossidabile - TCN 10/24" type Noxide/S.Steel Nozzle

Con deflettore estraibile e lavabile in acciaio inox - Con valvola antigoccia

With Stainless Steel impeller plate, which is able to be taken apart for cleaning - Anti-drip check valve

Senza filtro SERIE ECONOMY - Without filter - ECONOMY SERIES

Cod.	Item No.	Orifice	Orifice	Anti-drip type	
EC030152		0.15mm	.006"	NBR	55
EC030202		0.20mm	.008"	NBR	55
EC030302		0.30mm	.012"	NBR	55
EC030402		0.40mm	.015"	NBR	55
EC030502		0.50mm	.020"	NBR	55
EC030802		0.80mm	.030"	NBR	55
EC031002		1.00mm	.040"	NBR	55
EC040302	MosKITo	0.30mm	.012"	NBR	30

**NOXIDE**  
Oxidation-Acids  
Resistive coating

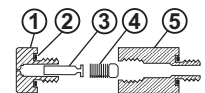

TCN ECONOMY

1-Testina 2-O-Ring 3-Pistoncino antigoccia 4-Molla antigoccia 5-Corpo 6-Filtro  
1-Head 2-O-ring 3-Anti-drip piston 4-Anti-drip spring 5-Body 6-Filter



Tappo esclusione ugello in ottone nichelato - Nickel-plated Brass Nozzle Plug - 10/24unc/2A

Cod.	Item No.	Description
EC080007		*Filettatura - Thread No.: 10/24unc/2A

## CLEANABLE NOZZLES and ACCESSORIES

### UGELLI NEBULIZZATORI e ACCESSORI

**NOXIDE**  
Oxidation-Acids  
Resistive coating

Prolunghe per ugelli in Ottone  
Brass nozzle extenders

Prolunghe flessibili in Ottone-Rame  
Flexible Brass-Copper nozzle extenders

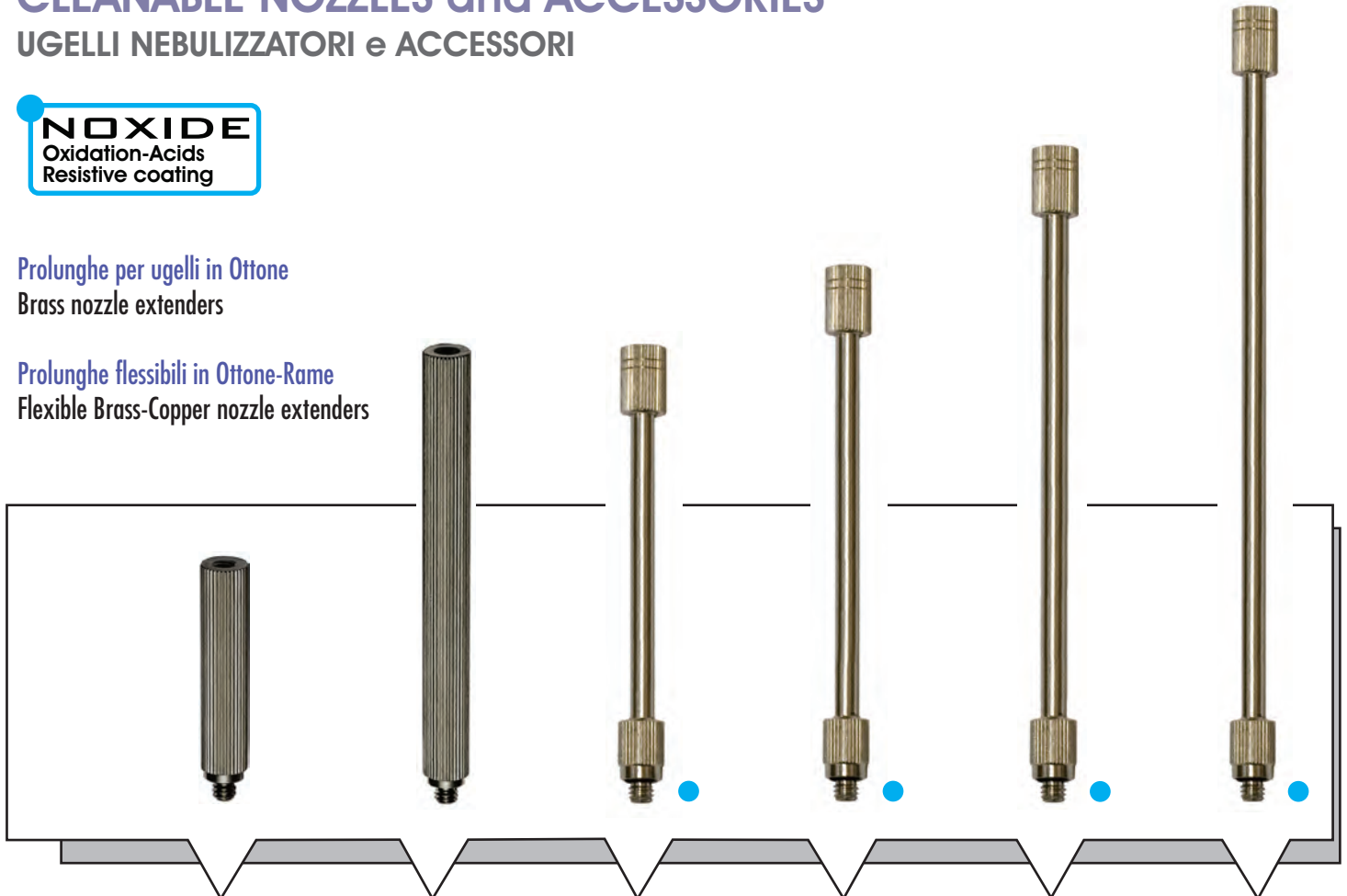

Cod.	Item No.	Lenght	Description
EC41010A	CV1010-05cm	5 cm - 1.97 in	* Filetto Femmina - Female Thread: 10/24" * Filetto Maschio - Male Thread: 10/24"
EC41010B	CV1010-10cm	10 cm - 3.94 in	
EC41010C	FLEX-10cm	10 cm - 3.94 in	* Filetto Femmina - Female Thread: 10/24" * Filetto Maschio - Male Thread: 10/24"
EC41015C	FLEX-15cm	15 cm - 5.90 in	
EC41020C	FLEX-20cm	20 cm - 7.87 in	* Filetto Femmina - Female Thread: 10/24" * Filetto Maschio - Male Thread: 10/24"
EC41030C	FLEX-30cm	30 cm - 11.81 in	



Cod.	Item No.	Description
EC410901		Connettore per 4 ugelli ad ombrello 4 nozzles umbrella adapter 1x M10/24" - 4x F10/24"



Cod.	Item No.	Description
EC410902		Connettore per 3 ugelli ad ombrello 3 nozzles umbrella adapter 1x M10/24" - 3x F10/24"



Cod.	Item No.	Description
EC410900		Raccordo orientabile a sfera MF 10/24" Adjustable angle coupling MF 10/24"

**NOXIDE**  
Oxidation-Acids  
Resistive coating

Special fittings for FANS and MISTING LINES  
Raccordi speciali per VENTILATORI e LINEE NEBULIZZAZIONE



Testina portaugelli Noxide - Noxide nozzle holder

Cod. - Part# **EC300022**  
Description  
\* Rosa 5 ugelli 1/8"F - 5x Nozzle holder F 1/8" G  
\* Per nr. 5 ugelli con filetto 10/24unc  
\* For no. 5 nozzles thread 10/24unc



Niplo M 1/8"G - M 10/24unc Noxide - Noxide nipple M 1/8"G - M 10/24unc

Cod. - Part# **EC300023**  
Description  
\* Filetto - Thread: M 1/8"G - M 10/24unc

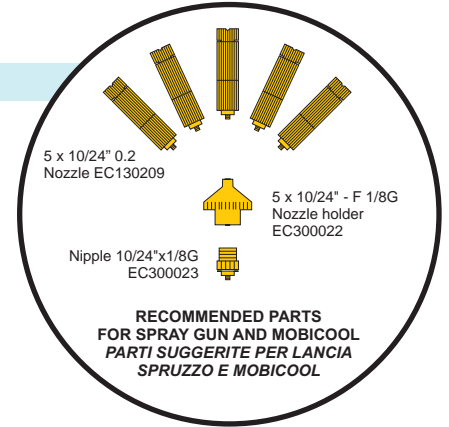

ACCESSORIES for DISINFECTION systems  
Accessori per sistemi di decontaminazione

30.0000.00  
**RL16 3/8"F**  
160 BAR  
30 l/min - 8 USGpm  
100 °C - 210 °F  
IN G3/8" F - OUT G1/4" F  
160 bar - 16 MPa - 2300 psi  
Q.tà- Q.ty: 1

00058090  
**TMT3 S.Steel lance Lancia Inox TMT3**  
Pressione / Pressure 280 BAR - 28MPa - 4100 psi  
Portata / Flow 40 l/min - 10.5 USGpm  
Temperatura / Temperature 150 °C - 300 °F  
Q.ty - Q.tà: 1

R7 TUBO / HOSE  
250 BAR  
Q.ty - Q.tà: 1

High pressure R7 flexible hose 250 bar (3600 psi)  
Tubo flessibile alta pressione R7 max. 250 bar (3600 psi)

Caratteristiche tecniche / Technical features

Type Tipo	Code Codice	Pressure Pressione		Ø Diam.	Length Lunghezza	Inlet In	Outlet Out	Weight Kg
		Bar	psi					
R7	TMTR7/10F	250	3625	1/4"	10	G1/4" F	G1/4" F	-
R7	TMTR7/15F	250	3625	1/4"	15	G1/4" F	G1/4" F	-
R7	TMTR7/20F	250	3625	1/4"	20	G1/4" F	G1/4" F	-
R7	TMTR7/30F	250	3625	1/4"	30	G1/4" F	G1/4" F	-

TC309069  
**Motion sensor**  
Sensore di movimento  
IP 55 Motion sensor  
External installation  
0.8 W / CE certified  
110-230V 50/60Hz  
Temp. range -30+50 °C  
Q.tà- Q.ty: 1

26.0030.31  
**AR1 - "A" Nipple M22**  
250 BAR  
G3/8" M - M22x1,5 M d.14  
250 bar - 25 MPa - 3650 psi  
40 l/min - 10.5 USGpm  
160 °C - 320 °F  
Q.ty - Q.tà: 1

26.0250.30  
**AR1 "B" Coupler M22**  
250 BAR 1/4"M  
IN G1/4" M - OUT M22x1,5 F d.14  
250 bar - 25 MPa - 3650 psi  
40 l/min - 10.5 USGpm  
160 °C - 320 °F  
Q.ty - Q.tà: 1

## FOG NOZZLES FLOW RATES TABLE

### TABELLA PORTATE UGELLI NEBULIZZATORI

Tested with water under controlled Laboratory conditions and 1 U.S. Gallon = 3.78 Liters approx.  
 \*\*\*Other orifice sizes available on request.

Dati rilevati da test di laboratorio.  
 Conversione 1 U.S. Gallon = 3.78 Litri  
 \*\*\*Ugelli con foro/portata fuori standard su richiesta



Tabella: Portata (GPH) (LPH) (LPM) alle pressioni indicate (BAR) (PSI)  
 Table: Flow rate (GPH) (LPH) (LPM) versus operating pressure (BAR) (PSI)

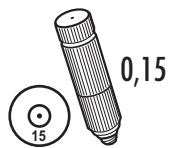

ORIFICE DIAMETER	BAR	3	4	7	10	15	25	35	45	70	84	100
	PSI	42	56	100	142	213	355	500	640	1000	1200	1420
.006"/.15 mm	GPH		--	--	--	--	0.44	0.52	0.60	<b>0.73</b>	0.80	0.93
	LPH						1.68	1.98	2.28	<b>2.76</b>	3.06	3.54
	LPM						0.0280	0.0330	0.0380	<b>0.0460</b>	0.0510	0.0590

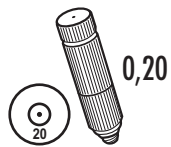

.008"/.20mm	GPH		--	--	--	--	0.77	0.92	1.05	<b>1.25</b>	1.55	1.60
	LPH						2.88	3.41	3.86	<b>4.72</b>	5.88	6.06
	LPM						0.0480	0.0568	0.0643	<b>0.0787</b>	0.0980	0.1010

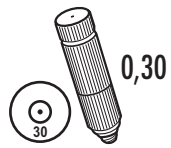

.012"/.30mm	GPH	0.37	0.43	0.55	0.68	0.78	1.03	1.23	1.41	<b>1.74</b>	2.52	2.63
	LPH	1.34	1.55	2.05	2.45	3.00	3.87	4.74	5.20	<b>6.48</b>	9.54	9.96
	LPM						0.0645	0.0790	0.0867	<b>0.1080</b>	0.1590	0.1660

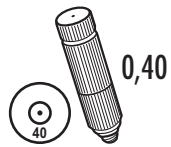

.015"/.40mm	GPH	0.51	0.59	0.76	0.93	1.07	1.42	1.69	1.93	<b>2.39</b>	3.09	3.19
	LPH	1.81	2.13	2.81	3.36	4.12	5.32	6.29	7.14	<b>8.90</b>	11.70	12.06
	LPM						0.0887	0.1048	0.1190	<b>0.1483</b>	0.1950	0.2010

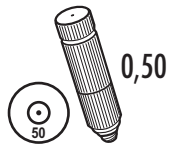

.020"/.50mm	GPH	0.69	0.80	1.03	1.26	1.46	1.93	2.31	2.63	<b>3.26</b>	4.23	4.36
	LPH	2.51	2.90	3.83	4.58	5.61	7.24	8.57	9.72	<b>12.12</b>	16.02	16.50
	LPM						0.1207	0.1428	0.1620	<b>0.2020</b>	0.2670	0.2750

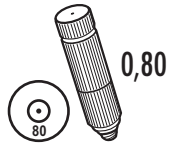

.030"/.80mm	GPH									<b>4.43</b>		
	LPH									<b>16.80</b>		
	LPM									<b>0.2800</b>		

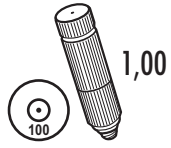

.040"/1.00 mm	GPH									<b>7.13</b>		
	LPH									<b>27.00</b>		
	LPM									<b>0.4500</b>		





Outdoor Cooling  
Cooling Fans  
Pre-cooling  
Raffrescamento  
ambienti esterni  
Ventilazione fredda  
Precooling

Humidification  
Greenhouses  
Livestock  
Umidificazione  
Serre  
Allevamenti

Decontamination  
Odor and Dust  
suppression  
Decontaminazione  
Abbattimento  
polveri e odori

Special Effects  
Effetti scenografici

#### TECNOCOOLING

Via Canale, 114 Loc. Villalunga  
42013 CASALGRANDE (RE) - ITALY  
info@tecnocooling.com



5553 W. Waters Av., Suite 311  
TAMPA FL 33634 U.S.A.  
us@tecnocooling.com



www.tecnocooling.com



*This product saves energy! - Questo prodotto ti fa risparmiare energia!*



**tecno****cooling**<sup>®</sup>